



# High Density Mounting Type Photocoupler

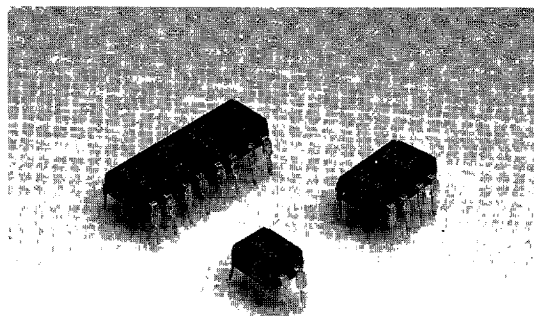
LTV817/LTV827/LTV847

T-41-83

PHOTOCOUPERS

## FEATURES

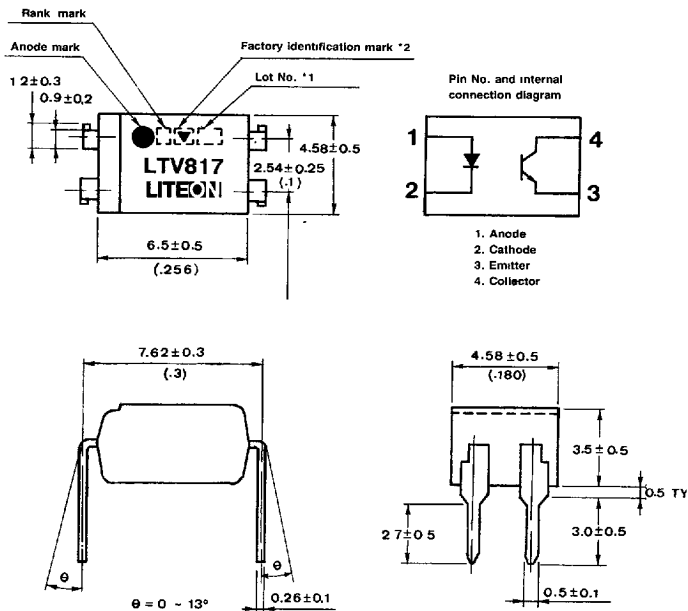
1. Current transfer ratio  
CTR: MIN. 50% at  $I_F = 5\text{mA}$ ,  $V_{CE} = 5\text{V}$
2. High input-output isolation voltage  
( $V_{ISO}$ : 5,000 Vrms)
3. Compact dual-in-line package  
LTV817: 1-channel type, LTV827: 2-channel type  
LTV847: 4-channel type
4. UL approved (No. E 113898(s))



## APPLICATIONS

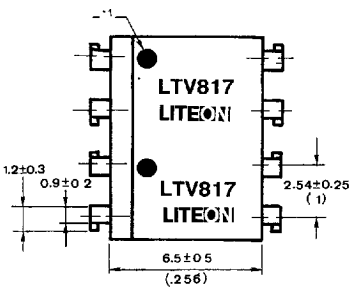
1. Computer terminals
2. System appliances, measuring instruments
3. Registers, copiers, automatic vending machines
4. Electric home appliances such as fan heaters, etc.
5. Medical instruments, physical and chemical equipments.
6. Signal transmission between circuits of different potentials and impedances

## OUTLINE DIMENSIONS (UNIT: mm)

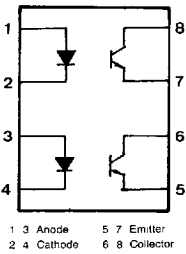


\*1 2-digit number marked according to DIN standard  
 \*2 Two versions available, one with factory identification mark and the other without

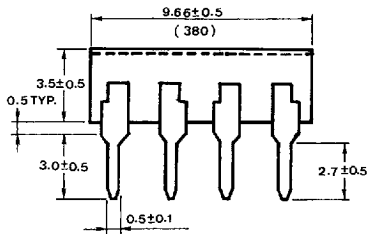
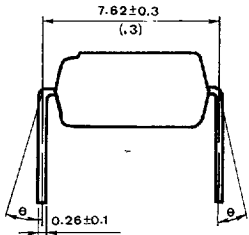
T-41-83



Pin No. and internal connection diagram

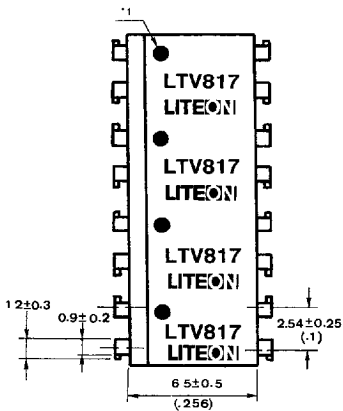


- 1 3 Anode
- 2 4 Cathode
- 5 7 Emitter
- 6 8 Collector

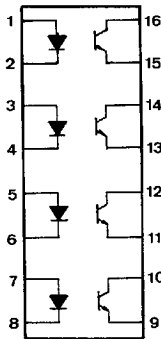


θ = 0 - 13°

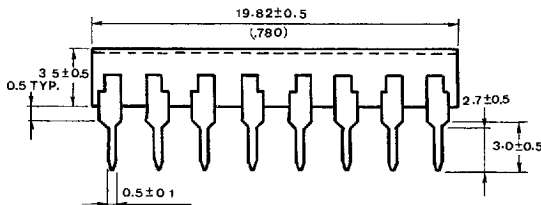
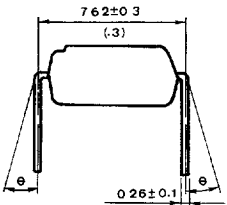
Note: \*1 Anode mark



Pin No. and internal connection diagram



- 1 3 5 7 Anode
- 2 4 6 8 Cathode
- 9 11 13 15 Emitter
- 10 12 14 16 Collector



θ = 0 - 13°

Note: \*1 Anode mark

T-41-83

## ■ RATINGS AND CHARACTERISTICS

### • Absolute maximum ratings

(Ta=25°C)

Parameter		Symbol	Rating	Unit
Input	Forward current	I <sub>F</sub>	50	mA
	*1 Peak forward current	I <sub>FM</sub>	1	A
	Reverse voltage	V <sub>R</sub>	6	V
	Power dissipation	P	70	mW
Output	Collector-emitter voltage	V <sub>CEO</sub>	35	V
	Emitter-collector voltage	V <sub>ECO</sub>	6	V
	Collector current	I <sub>C</sub>	50	mA
	Collector power dissipation	P <sub>C</sub>	150	mW
Total power dissipation		P <sub>tot</sub>	200	mW
Operating temperature		T <sub>opr</sub>	-30 ~ +100	°C
Storage temperature		T <sub>stg</sub>	-55 ~ +125	°C
*2 Isolation voltage		V <sub>iso</sub>	5	kVrms
*3 Soldering temperature		T <sub>sol</sub>	260	°C

\*1 Pulse width ≤ 100μs, Duty ratio: 0.001

\*2 AC for 1 minute, 40~60% R.H.

\*3 For 10 seconds

## • Electro-optical characteristics

(Ta=25°C)

Parameter		Symbol	Min.	Typ.	Max.	Unit	Conditions
Input	Forward voltage	$V_F$	—	1.2	1.4	V	$I_F = 20\text{mA}$
	Peak forward voltage	$V_{FM}$	—	—	3.0	V	$I_{FM} = 0.5\text{A}$
	Reverse current	$I_R$	—	—	10	$\mu\text{A}$	$V_R = 4\text{V}$
	Terminal capacitance	$C_t$	—	30	250	pF	$V = 0, f = 1\text{kHz}$
Output	Collector dark current	$I_{CEO}$	—	—	100	nA	$V_{CE} = 20\text{V}, I_F = 0, R_{BE} = \infty$
	Collector-emitter breakdown voltage	$BV_{CEO}$	35	—	—	V	$I_C = 0.1\text{mA}, I_F = 0$
	Emitter-collector breakdown voltage	$BV_{ECO}$	6	—	—	V	$I_E = 10\mu\text{A}, I_F = 0$
Transfer characteristics	* Collector current	$I_C$	2.5	—	30	mA	$I_F = 5\text{mA}, V_{CE} = 5\text{V}$
	Collector-emitter saturation voltage	$V_{CE}(\text{sat})$	—	0.1	0.2	V	$I_F = 20\text{mA}, I_C = 1\text{mA}$
	Isolation resistance	$R_{ISO}$	$5 \times 10^{10}$	$10^{11}$	—	$\Omega$	500V DC, 40~60% R.H.
	Floating capacitance	$C_f$	—	0.6	1.0	pF	$V = 0, f = 1\text{MHz}$
	Cut-off frequency	$f_c$	—	80	—	kHz	$V_{CE} = 5\text{V}, I_C = 2\text{mA}$ $R_L = 100\Omega, -3\text{dB}$
	Response time (Rise)	$t_r$	—	4	18	$\mu\text{s}$	$V_{CE} = 2\text{V}, I_C = 2\text{mA},$ $R_L = 100\Omega$
	Response time (Fall)	$t_f$	—	3	18	$\mu\text{s}$	

A-85  
100

$$*CTR = \frac{I_C}{I_F} \times 100\%$$

T-41-83

## ■ SUPPLEMENT

### • Isolation voltage shall be measured in the following method.

- (1) Anode and cathode on input side, collector and emitter on output side shall be shortened individually.
- (2) The isolation voltage tester with a zero-cross circuit shall be used.
- (3) The waveform of applied voltage shall be a sine wave.

(It is recommended that the isolation voltage shall be measured in insulation oil.)

### • Rank table of collector current $I_C$ (for LTV 817 only)

Model No.	Rank mark	$I_C$ (mA)
LTV817A	A	4.0~8.0
LTV817B	B	6.5~13
LTV817C	C	10~20
LTV817D	D	15~30
LTV817	A, B, C, D or No mark	2.5~30

Conditions	$I_F = 5\text{mA}$ $V_{CE} = 5\text{V}$ $T_a = 25^\circ\text{C}$
------------	--

### • Inspection standard

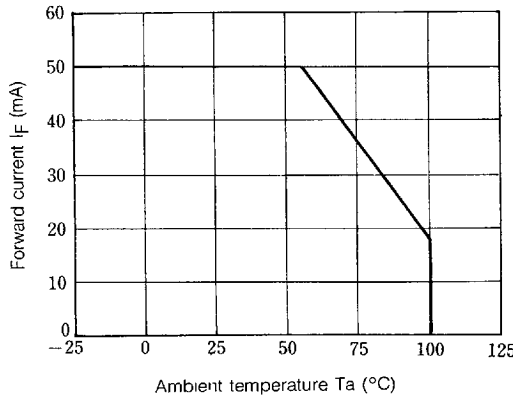
Outgoing inspection standard for LITON products are shown below.

- (1) A single sampling plan, normal inspection level II based on MIL-STD-105D is applied. The AQL according to the inspection items are shown below.

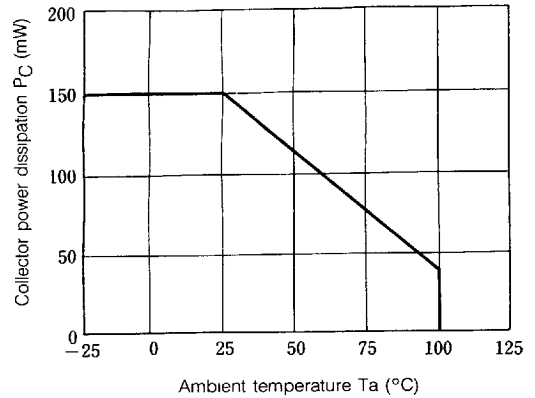
Defect	Inspection item	AQL (%)	Judgement criterion
Major defect	<ul style="list-style-type: none"> <li>• Electrical characteristics</li> <li>• Unreadable marking</li> <li>• Open, short</li> </ul>	0.25	Depend on the specification
Minor defect	<ul style="list-style-type: none"> <li>• Appearance</li> <li>• Dimension</li> </ul>	0.4	

T-41-83

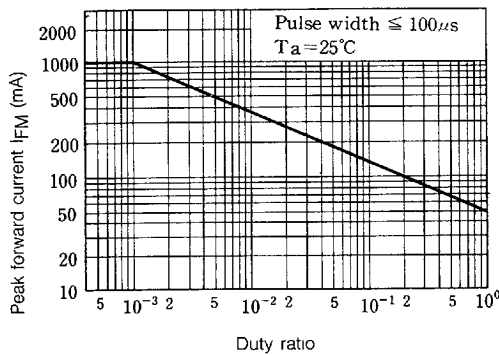
**Fig. 1** Forward Current vs. Ambient Temperature



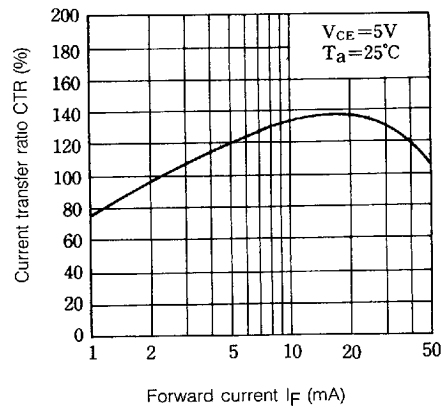
**Fig. 2** Collector Power Dissipation vs. Ambient Temperature



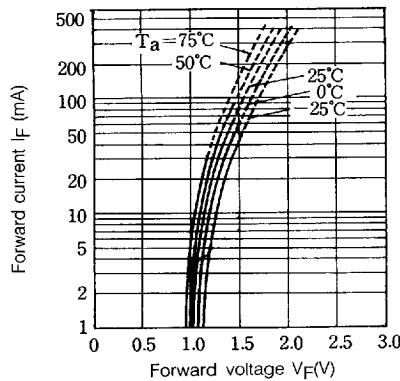
**Fig. 3** Peak Forward Current vs. Duty Ratio



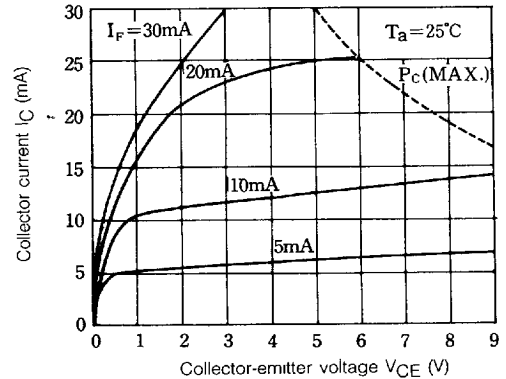
**Fig. 4** Current Transfer Ratio vs. Forward Current



**Fig. 5** Forward Current vs. Forward Voltage

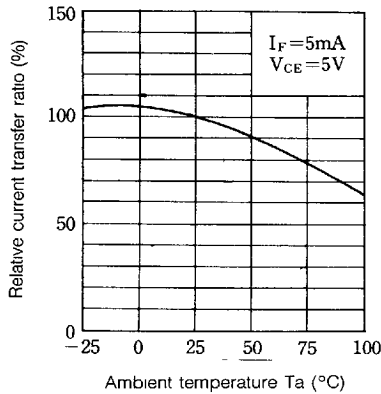


**Fig. 6** Collector Current vs. Collector-emitter Voltage

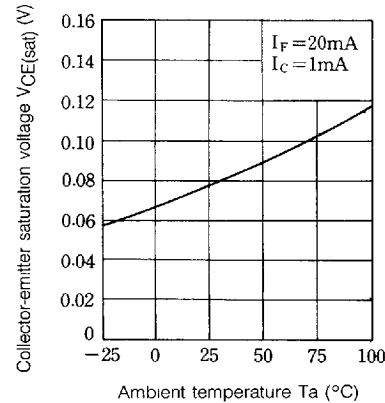


T-41-83

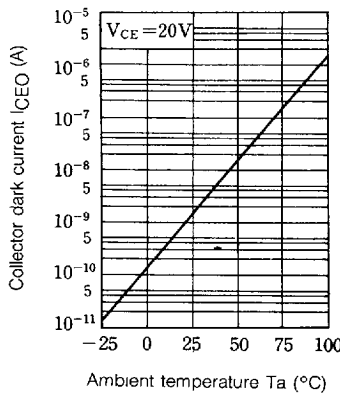
**Fig. 7** Relative Current Transfer Ratio vs. Ambient Temperature



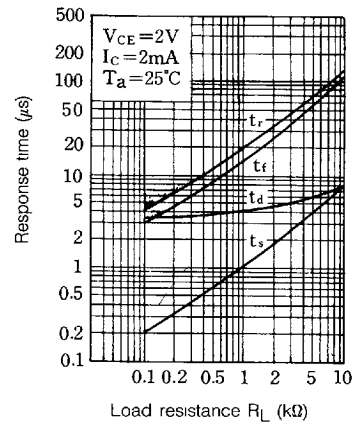
**Fig. 8** Collector-emitter Saturation Voltage vs. Ambient Temperature



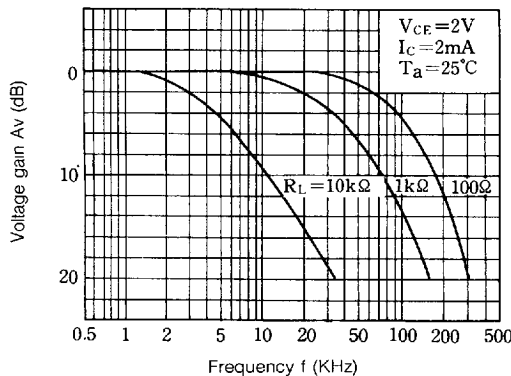
**Fig. 9** Collector Dark Current vs. Ambient Temperature



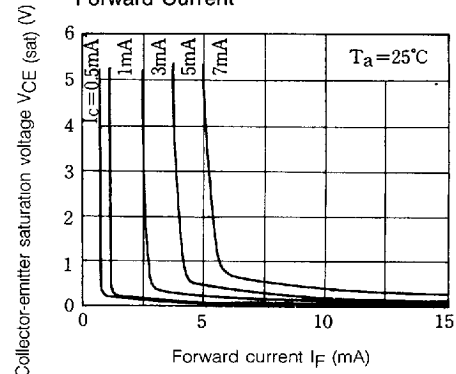
**Fig. 10** Response Time vs. Load Resistance



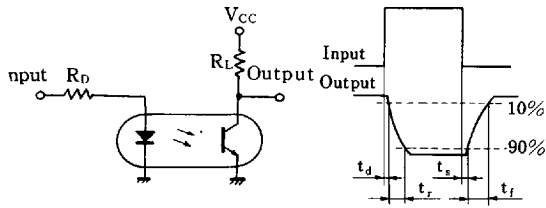
**Fig. 11** Frequency Response



**Fig. 12** Collector-emitter Saturation Voltage vs. Forward Current



Test Circuit for Response Time



Test Circuit for Frequency Response

