



Dual N-Channel 30-V (D-S) MOSFET with Schottky Diode

PRODUCT SUMMARY		
V_{DS} (V)	$r_{DS(on)}$ (Ω)	I_D (A)
30	0.022 @ $V_{GS} = 10$ V	7.5
	0.030 @ $V_{GS} = 4.5$ V	6.5

SCHOTTKY PRODUCT SUMMARY		
V_{DS} (V)	V_{SD} (V) Diode Forward Voltage	I_F (A)
30	0.50 V @ 1.0 A	2.0

LITTLE FOOT PLUS™

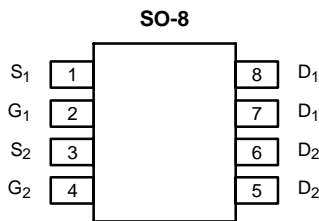

Top View

Ordering Information: Si4808DY
Si4808DY-T1 (with Tape and Reel)

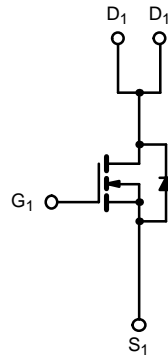

N-Channel MOSFET

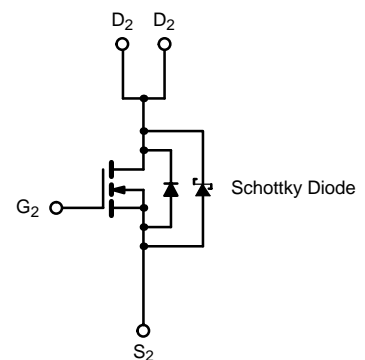

N-Channel MOSFET

ABSOLUTE MAXIMUM RATINGS ($T_A = 25^\circ\text{C}$ UNLESS OTHERWISE NOTED)					
Parameter	Symbol	10 secs	Steady State	Unit	
Drain-Source Voltage	V_{DS}	30		V	
Gate-Source Voltage	V_{GS}	± 20			
Continuous Drain Current ($T_J = 150^\circ\text{C}$) ^a	I_D	$T_A = 25^\circ\text{C}$	7.5	5.7	A
		$T_A = 70^\circ\text{C}$	6.0	4.6	
Pulsed Drain Current	I_{DM}	30			
Continuous Source Current (Diode Conduction) ^a	I_S	1.7	0.9		
Maximum Power Dissipation ^a	P_D	$T_A = 25^\circ\text{C}$	2.0	1.1	W
		$T_A = 70^\circ\text{C}$	1.3	0.7	
Operating Junction and Storage Temperature Range	T_J, T_{stg}	-55 to 150		$^\circ\text{C}$	

THERMAL RESISTANCE RATINGS							
Parameter	Symbol	MOSFET		Schottky		Unit	
		Typ	Max	Typ	Max		
Maximum Junction-to-Ambient ^a	R_{thJA}	$t \leq 10$ sec	52	62.5	53	62.5	$^\circ\text{C/W}$
		Steady-State	93	110	93	110	
Maximum Junction-to-Foot (Drain)	R_{thJC}	35	40	35	40		

Notes

a. Surface Mounted on 1" x 1" FR4 Board.

MOSFET SPECIFICATIONS (T_J = 25 °C UNLESS OTHERWISE NOTED).							
Parameter	Symbol	Test Condition	Min	Typ ^a	Max	Unit	
Static							
Gate Threshold Voltage	V _{GS(th)}	V _{DS} = V _{GS} , I _D = 250 μA	0.8			V	
Gate-Body Leakage	I _{GSS}	V _{DS} = 0 V, V _{GS} = ±20 V			±100	nA	
Zero Gate Voltage Drain Current	I _{DSS}	V _{DS} = 24 V, V _{GS} = 0 V	Ch-1		1	μA	
			Ch-2		100		
		V _{DS} = 24 V, V _{GS} = 0 V, T _J = 85 °C	Ch-1		15		
			Ch-2		2000		
On-State Drain Current ^b	I _{D(on)}	V _{DS} = 5 V, V _{GS} = 10 V	20			A	
Drain-Source On-State Resistance ^b	r _{DS(on)}	V _{GS} = 10 V, I _D = 7.5 A		0.018	0.022	Ω	
		V _{GS} = 4.5 V, I _D = 6.5 A		0.024	0.030		
Forward Transconductance ^b	g _{fs}	V _{DS} = 15 V, I _D = 7.5 A		22		S	
Diode Forward Voltage ^b	V _{SD}	I _S = 1 A, V _{GS} = 0 V	Ch-1		0.8	1.2	V
			Ch-2		0.47	0.5	
Dynamic^a							
Total Gate Charge	Q _g	V _{DS} = 15 V, V _{GS} = 10 V, I _D = 7.5 A		13	20	nC	
Gate-Source Charge	Q _{gs}			2			
Gate-Drain Charge	Q _{gd}			2.7			
Gate Resistance	R _g		0.5		3.2	Ω	
Turn-On Delay Time	t _{d(on)}	V _{DD} = 15 V, R _L = 15 Ω I _D ≅ 1 A, V _{GEN} = 10 V, R _G = 6 Ω		8	16	ns	
Rise Time	t _r			10	20		
Turn-Off Delay Time	t _{d(off)}			21	40		
Fall Time	t _f			10	20		
Source-Drain Reverse Recovery Time	t _{rr}	I _F = 1.7 A, di/dt = 100 A/μs	Ch-1		40	80	
			Ch-2		32	70	

Notes

- a. Guaranteed by design, not subject to production testing.
b. Pulse test; pulse width ≤ 300 μs, duty cycle ≤ 2%.

SCHOTTKY SPECIFICATIONS (T_J = 25 °C UNLESS OTHERWISE NOTED)						
Parameter	Symbol	Test Condition	Min	Typ	Max	Unit
Forward Voltage Drop	V _F	I _F = 1.0 A		0.47	0.50	V
		I _F = 1.0 A, T _J = 125 °C		0.36	0.42	
Maximum Reverse Leakage Current	I _{rm}	V _r = 30 V		0.004	0.100	mA
		V _r = 30 V, T _J = 100 °C		0.7	10	
		V _r = -30 V, T _J = 125 °C		3.0	20	
Junction Capacitance	C _T	V _r = 10 V		50		pF



TYPICAL CHARACTERISTICS (25°C UNLESS NOTED) MOSFET

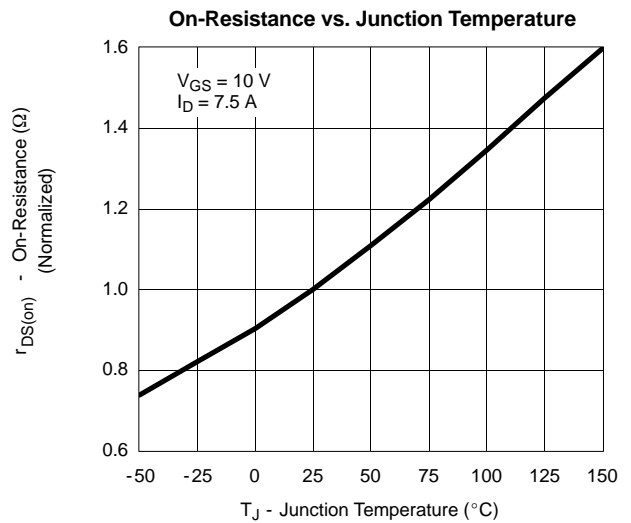
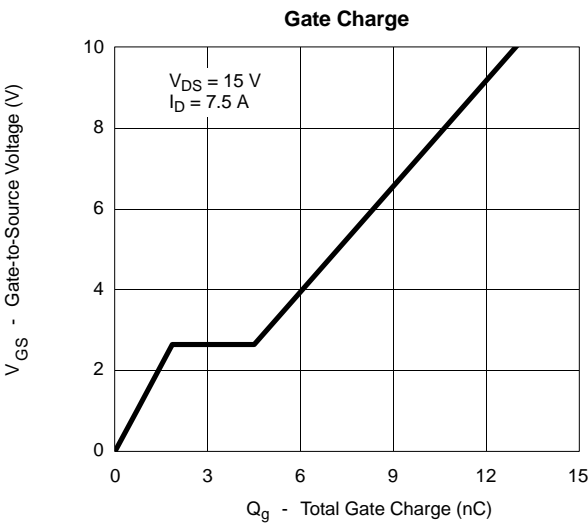
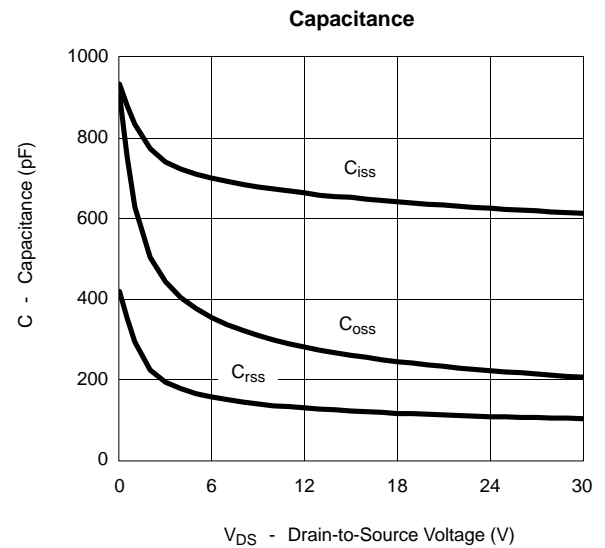
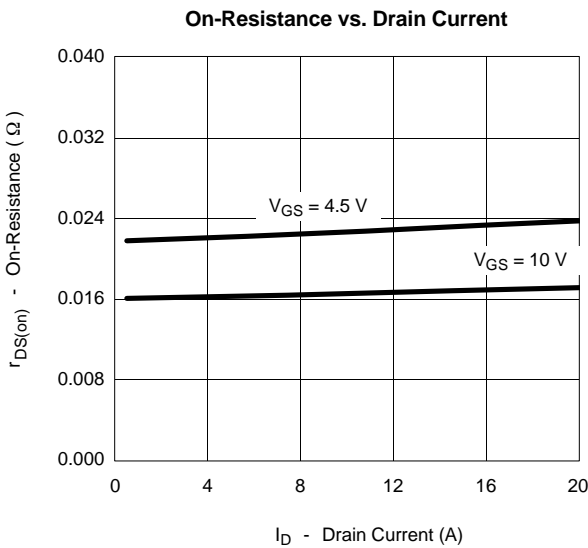
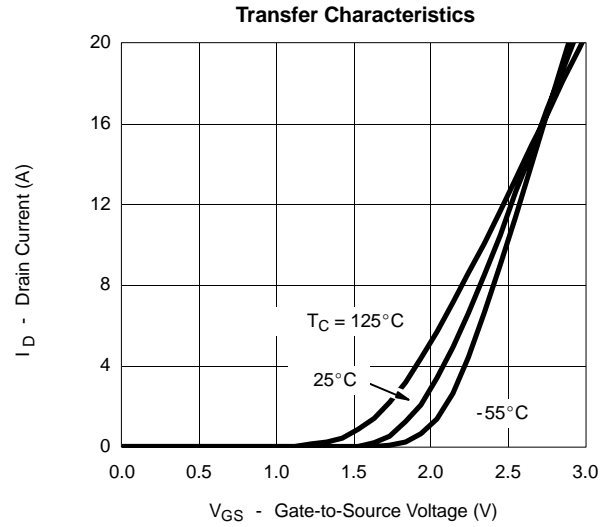
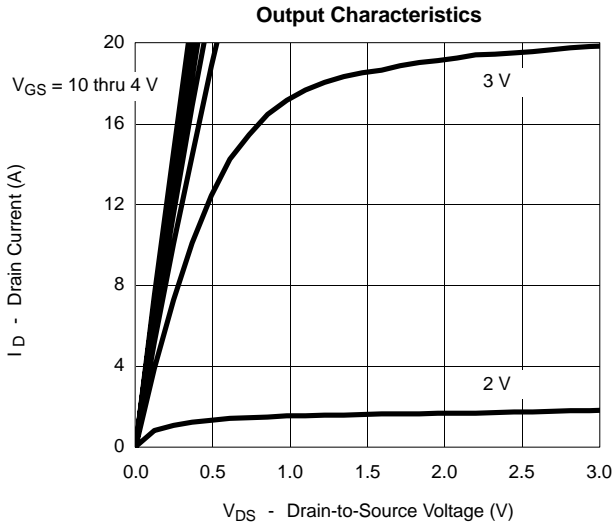



TYPICAL CHARACTERISTICS (25 °C UNLESS NOTED)

MOSFET

Source-Drain Diode Forward Voltage

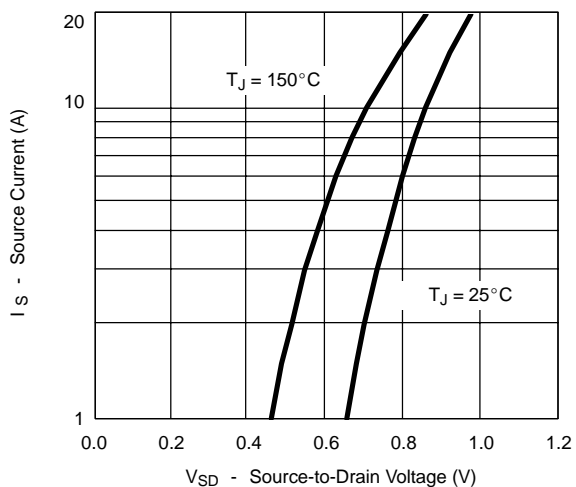

On-Resistance vs. Gate-to-Source Voltage

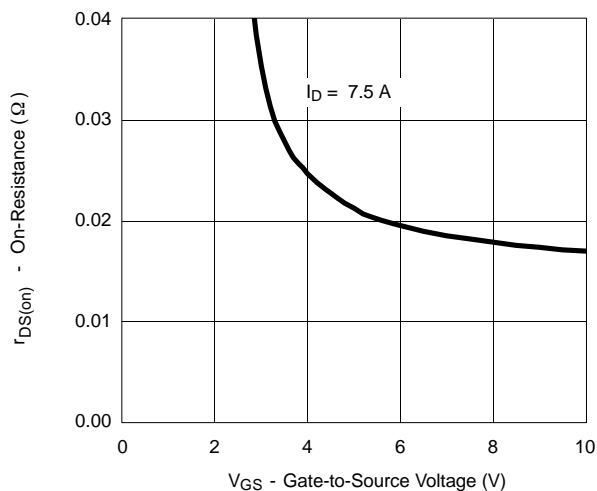

Threshold Voltage

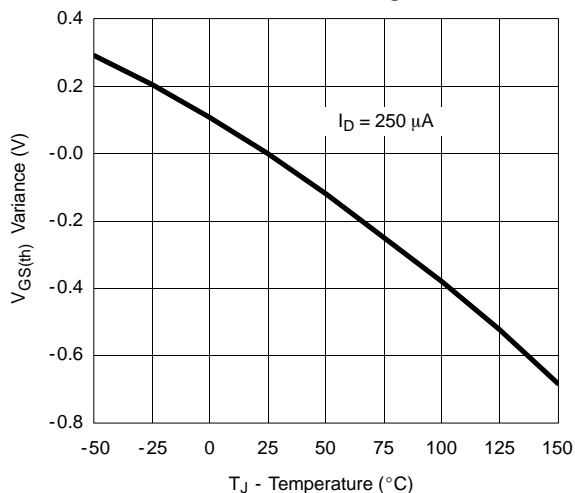

Single Pulse Power

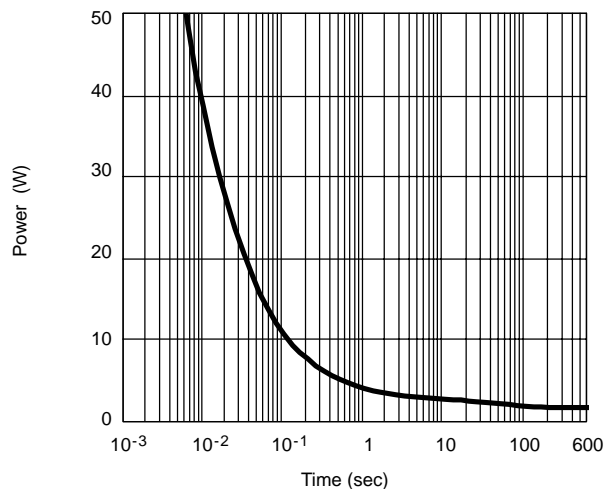

Normalized Thermal Transient Impedance, Junction-to-Ambient

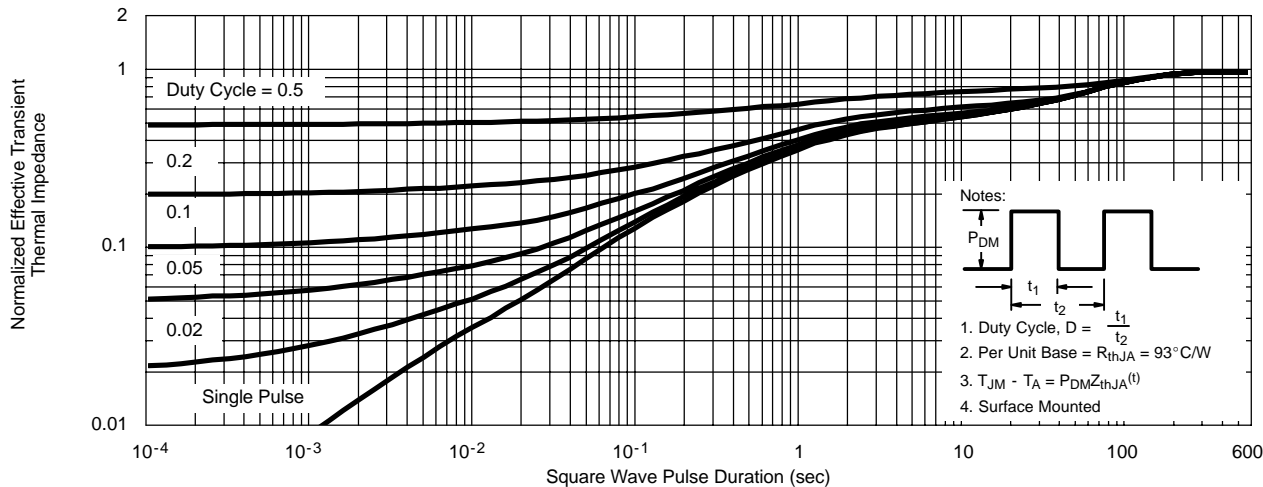



TYPICAL CHARACTERISTICS (25 °C UNLESS NOTED) MOSFET

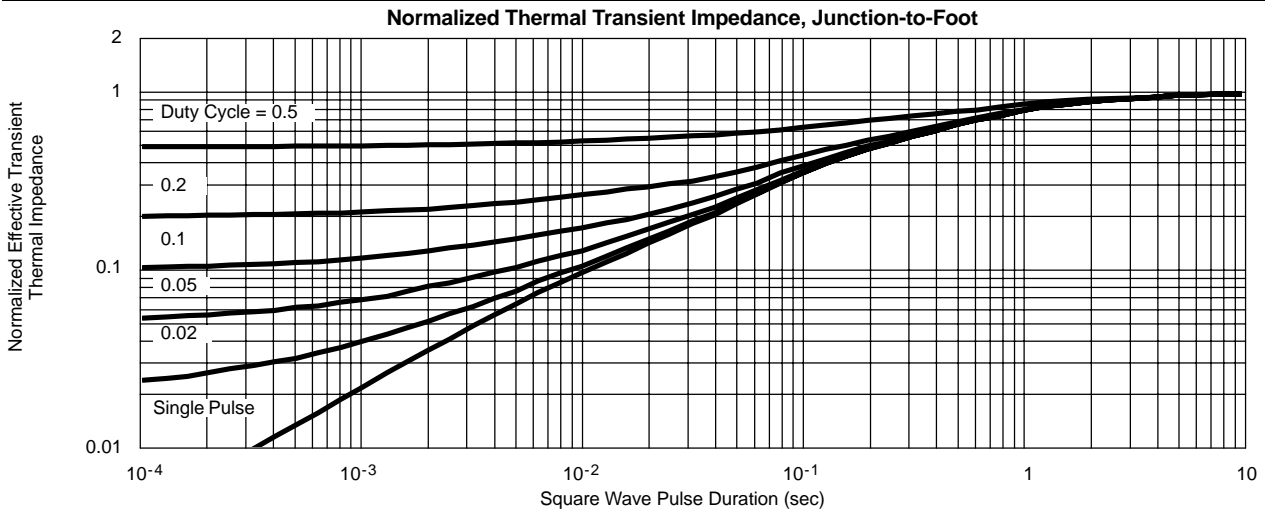

TYPICAL CHARACTERISTICS (25 °C UNLESS NOTED) SCHOTTKY

